

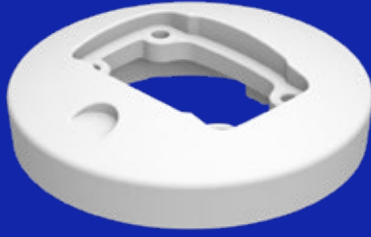

TS EN 50085-1
TS EN IEC 61439-1

5
YEARS
WARRANTY



ARM130.310

4x  **M8 x 40**

4x  **J8.4**

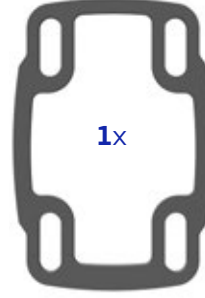

1

Sarı renkli bantı çıkarınız. Yapışkan yüzeyi içeri gelecek şekilde contayı yerleştiriniz.

(Remove the yellow tape. Place the gasket with the adhesive surface inside)

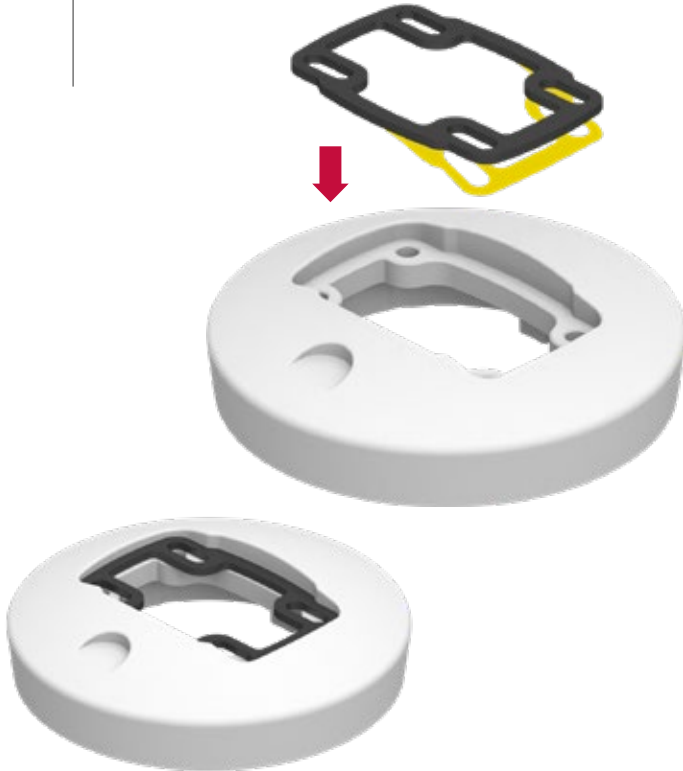

2

Profili ok yönünde içeri doğru yerleştiriniz.

(Insert the profile into the coupling as shown in the picture below)

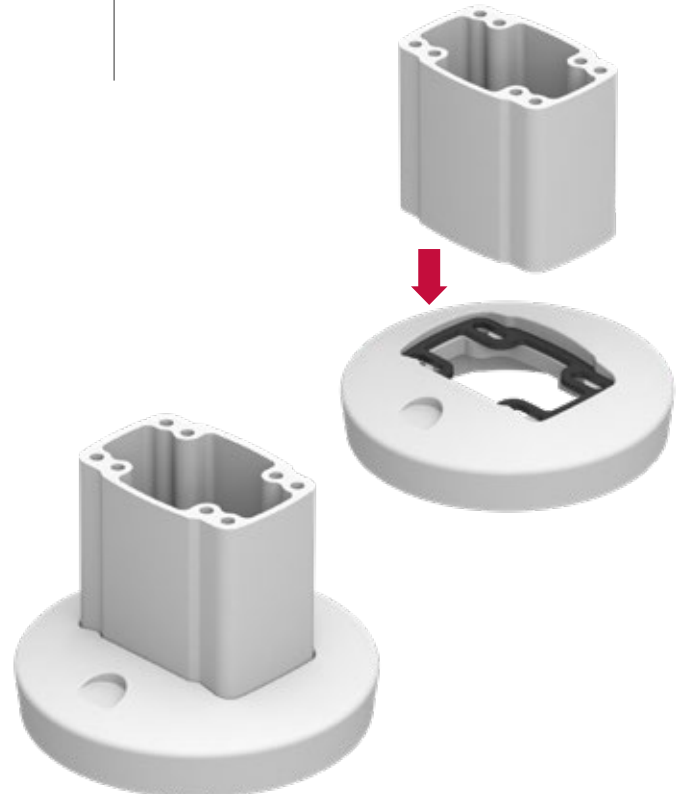

3

M8x40 profil civatalarını montajlayın.

(Assemble the M8x40 profile bolts)

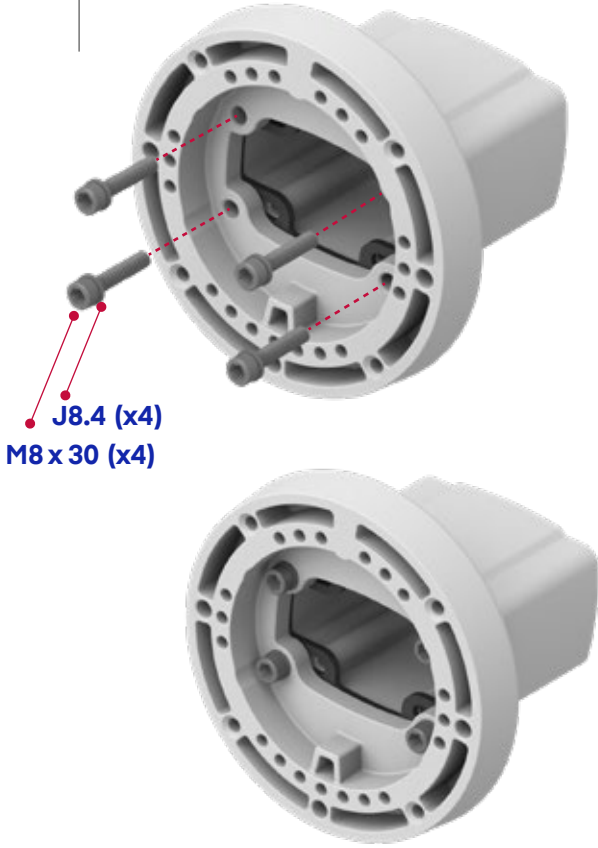

4

Modülü panel üzerine yerleştiriniz.

(Place the module on the panel)

M8x30 (x4) Civatalar kutu içeriğine dahil değildir.

(M8x30 (x4) Bolts are not included in the box)

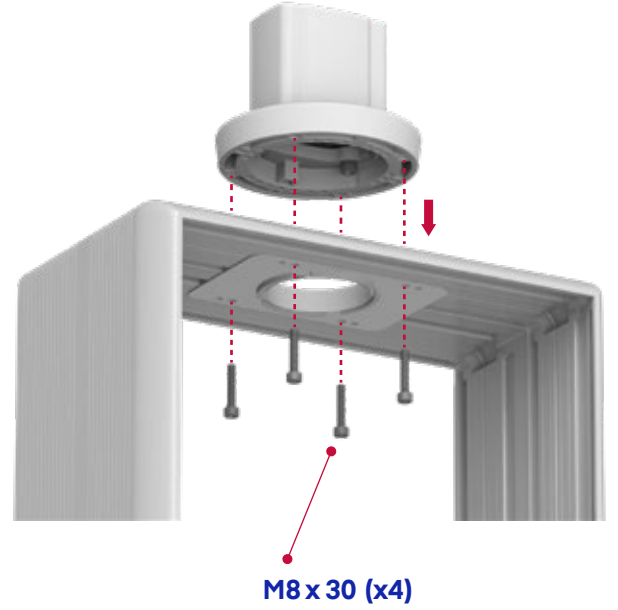

5

Panonun doğru montajlandığını kontrol ediniz.

(Check that the panel is mounted correctly)



6

Pano üzerine açılması gereken civata bağlantı delikleri ve kablo geçiş delik ölçüleri.

(Bolt connection holes and cable hole dimensions on the panel if required for assembly)

